

**Mud Sucker®
Diaphragm Pumps**

B Series

**Solids Crushing
Diaphragm Pumps**

4B-EC™

Standard Piping

FEATURES

4" Connection size

Pump up to 110 GPM

Transfer spherical solids up to
1¾" or 50% by volume

Pump up to 50' vertical or 300'
horizontal

1¾" heavy duty diaphragm

Multiple drive options and
industry specific components

PROFESSIONAL



Shown: Mud Sucker 4B-EC Series with optional air chambers to reduce water hammer.

The Mud Sucker brand 4B-EC is a Professional Series diaphragm pump designed and manufactured by Wastecorp. The 4B-EC is designed for heavy duty solids handling applications in wastewater treatment systems. 4B-EC customers include mining companies, food processors, municipal wastewater treatment, industrial fluid treatment and more.

Performance Range

Max. capacity	110 GPM
Max. suction lift	25' vertical or 75' horizontal
Max. discharge head	50' vertical or 300' horizontal
Solids handling	1¾" dia or 50% by volume

Pump and Motor Specifications

Suction inlet/outlet size	4"x4"
Max. liquid temperature	140°F (60°C) continuous
Pump body casing	Cast iron (ASTM A356, Class 30)
Diaphragm	1¾" dia thermoplastic elastomer (red) Severe duty -25°F to 212°F Optional: Neoprene
Ball valves	5-1/8" diameter polyurethane with steel core
Gearbox	Helical bevel cast iron housing with heat treated gears
Hardware	Zinc plated
Rod end bearing body	Cast iron, protective coated for corrosion resistance
Ball bearing	Cast iron, protective coating for corrosion resistance
Ultimate radial static load capacity	9,000 Lbs

Motor Options

Description	Part No.	Motor Option
Standard motor (TEFC)	61737-00	5 hp, 1800RPM/3/60/230-460V
Single phase (TEFC)	61737-10	5 hp, 1800RPM/1/60/230V
Explosion proof (three phase, TEXP)	61737-20	5 hp, 1800RPM/3/60/230-460V
Explosion proof (single phase, TEXP)	61737-30	5 hp, 1800RPM/1/60/115-230V

Mud Sucker® Diaphragm Pumps 4B Series

Professional Solids Handling Diaphragm Pumps

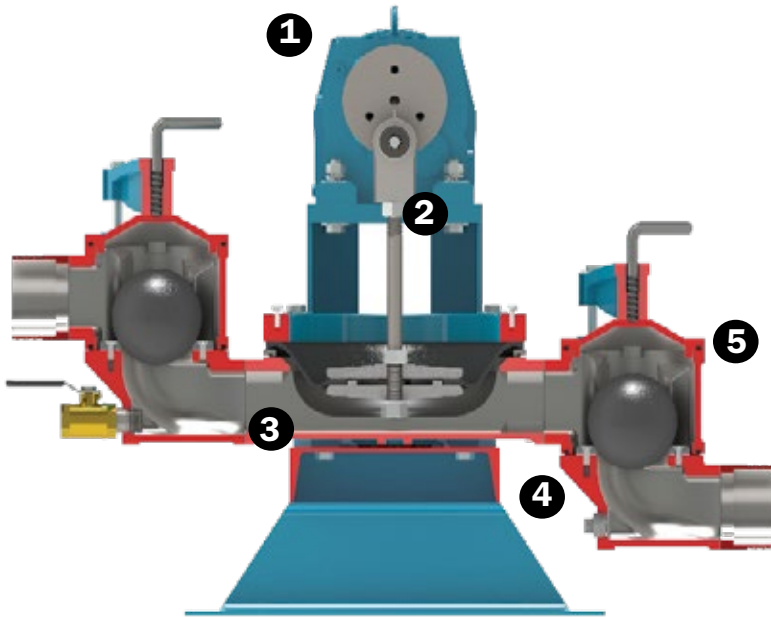

- 1** Premium drive systems from the industry's top rated manufacturers.
- 2** Heavy duty crank arm designed to pump the tough stuff at 110 GPM (max).
- 3** Exclusive Wastecorp engineered contoured velocity channel to move fluids without clogging.
- 4** Heavy duty cast iron pump body for unmatched durability.
- 5** Valve chambers crush solids and make slurries easier to pump.

Professional Options for Professional Applications



Wastewater Containment System



4B Series - Trolley Mounted



4B Series - Trailer Mounted



4B Series - Dolly Mounted

Mud Sucker® Diaphragm Pumps

Toll-Free North America
1.888.829.2783

Worldwide
201.445.2882















Website
<http://www.wastecorp.com>

E-mail
info@wastecorp.com

WASTECORP.
Pumps®
OEM Manufacturer



ACCESSORIES

Part no.	Description	Part no.	Description
 19022-00	Recommended! Pressure relief valve, bronze set at 40 psi	 61747-00	Utility trailer (non-DOT) w/2" ball hitch
 61740-00	Basic spare parts kit (diaphragm and flappers)	 61741-00	Comprehensive spare parts kit (diaphragm, flappers gaskets, weights and hardware)
 60728-00	Non-collapsible EPDM hose 2"x20'. Camlocks included	 Various	Wet section coatings for specific applications
 51333-10	Discharge hose, lay flat (brown) 2"x50'. Camlocks included	 62304-00	SEW Movimot 24V key pad speed control
 34383-00	Stainer, sq. hole (solids) 2" FNPT	 62350-00	Starter Control Panel w/ NEMA 12 protection
 61387-00	Universal sewer adapter assembly	 60469-00	Camlock fitting 4" alum. male adapter MNPT
 61537-00	Clear swing check valve 4" FPTxFPT	 60506-00	The Gulper™ Suction tool No more bending