

Mud Sucker®
Diaphragm Pumps

2FAC-EC Series

Multipurpose
Diaphragm Pumps

1.5FAC-EC™

2FAC-EC™

FEATURES

Pump up to 20 GPM

Runs dry without damage

Select from 1½" or 2"
connections

Transfer spherical solids up to
1.5" or 50% by volume

Pump weighs under 80 lbs

7" heavy duty diaphragm

Light weight aluminum pump
body

WASTECORP.
Pumps®

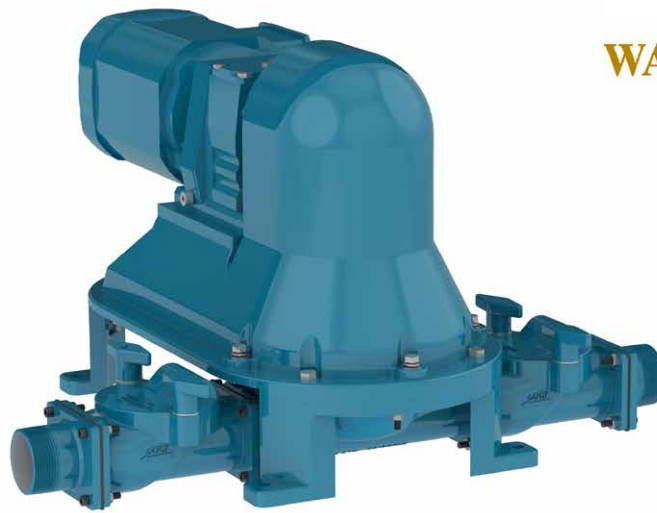

EXCEEDING THE DEMANDS OF ELECTRIC DIAPHRAGM PUMP USERS.

The Mud Sucker 2FAC-EC is an electric diaphragm pump manufactured by Wastecorp Pumps. The 2FAC-EC positive displacement pump can run dry without damage. This pump is designed to pump over 2000 types of fluids ranging from general wastewater and septic pumping to waste oil, vegetable oil, used motor oil, and food processing waste. The 2FAC-EC electric diaphragm pump sees a lot of applications. It's rated as one of the top multipurpose 2" electric pumps

The 2FAC-EC includes an enhanced velocity channel to move fluids and higher tensile strength components like neoprene or viton flappers. Plus, application specific components are available for the food

Make Pumping Tough Fluids Easier

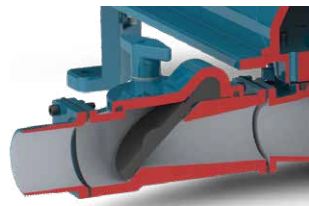

INNOVATIVE THINKING IN PUMP DESIGN

No other flapper valve diaphragm pump offers a more robust flapper check valve than a Mud Sucker. Pumping tough fluids just got more productive.



NEW! QUICK ACCESS TO PUMP INTERNALS

It has never been easier to access the internals of a flapper valve diaphragm pump. Simply twist the clamping bolts, remove the valve cover and you're in.



MULTIPLE CONFIGURATION OPTIONS

Stand alone units or packaged pump systems. We can help you plan a solution for your unique fluid handling environment.

WHAT THIS MEANS TO YOU.

Owning a Mud Sucker is like having a pump expert with you on site. These are intelligent pumps not to be confused with throw away makes.

You get a custom electric diaphragm pump solution that is designed for your application.

We design, build and manufacture your pump systems. Expert support and advice makes all the difference.

MUD SUCKER® DIAPHRAGM PUMPS THE PUMP WITH ATTITUDE.

wastecorp.com

Patent pending electric diaphragm pump design.

rev: oct 08 2020

Meet Mud Sucker 2FAC-EC Series

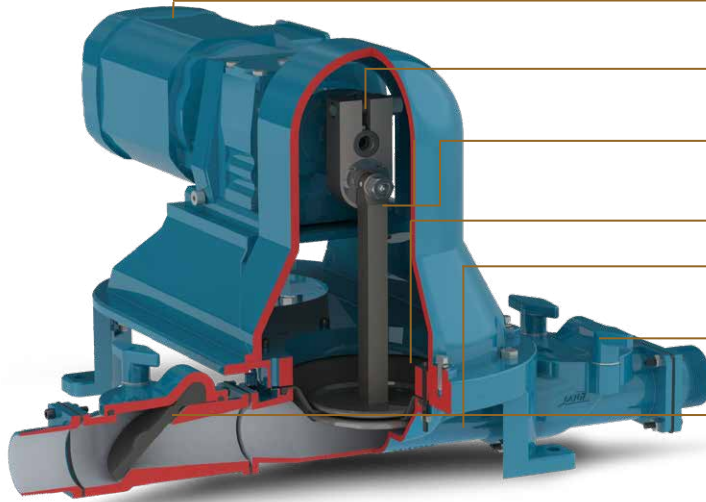

- Premium Siemens®, SEW Eurodrive® single or three phase drive system
- Heavy duty crank arm to pump the tough stuff at 20 GPM (max)
- Heavy duty pump rod design ensures consistent flow and performance
- 7" diaphragm
- Exclusive Wastecorp engineered velocity channel to move fluids without clogging
- Lightweight marine grade aluminum pump body

NEW! COMPLETELY REDESIGNED FLAPPER SYSTEM TO EASILY ACCESS INTERNALS AND REDUCE MAINTENANCE TIME

Manufactured in North America. Country/region specific models available worldwide.

Performance Range

Max. Capacity	20 GPM
Max. Suction Lift	20' vertical or 75' horizontal (with foot valve)
Max. Discharge Head	50' vertical or 22 psi max.
Solids Handling	1½" dia or 50% by volume

Pump and Motor Specifications

Suction Inlet/Outlet Size	1½" or 2" MNPT (optional male camlock)
Max. Liquid Temperature	140°F (60°C) continuous
Pump Body Casing	Aluminum A356, heat treated
Diaphragm	7" OD fabric reinforced
Flapper Valves	Neoprene or Viton
Crankarm & Pump Rod Assembly	AISI 12L14 carbon steel
Gear Reducer	Siemens or SEW Eurodrive
Max. Pump Operating Speed	70 RPM

Motor Specifications

Description	Part No.	Motor Option
Standard motor Three Phase (TEFC)	64722-00	1 hp, 1800 RPM/3/60/230/460V
Single Phase (TEFC)	64722-10	1 hp, 1800 RPM/1/60/115/230V
Explosion Proof (Three Phase), TEXP	64722-20	1 hp, 1800 RPM/3/60/230/460V
Explosion Proof (Single Phase), TEXP	64722-30	1 hp, 1800 RPM/1/60/115/230V

Also available with 12 V DC Power, 24V DC, gas, diesel, air or hydraulic drives. Optional in line piping configuration also available. Contact factory for optional Hertz/voltages available.

Performance Curve

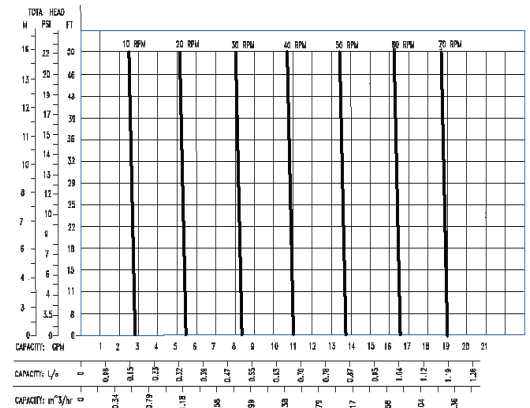

Mud Sucker® Diaphragm Pumps



















Toll-Free: 1.888.829.2783 Email: info@wastecorp.com



Mud Sucker 2FAC Series pumps are specified for marine pumping applications, waste oil pumping, leachate recovery, dewatering, biodiesel production and many other applications. Mention your application to your technical support representative at the time of order. Before operating your diaphragm pump, read, understand and follow all instructions in the manual and on the pump. Specifications and programs are accurate at the time of publication but subject to change without notice. Images may not reflect dealer inventory and/or unit specifications. Wastecorp, Mud Sucker and globes are trademarks of Wastecorp, WPI. No reproduction of this document without permission. © Wastecorp 2017. Electric diaphragm pump manufacturer.



ATTACHMENTS

Part no.	Description	Part no.	Description
	64093-02 RECOMMENDED! Pressure sensor assembly		61315-00 Wheel mount kit with handles
	65039-00 Basic spare parts kit (diaphragm and flappers)		62538-00 Mobility package (stationary) lifting bars
	60444-00 Comprehensive spare parts kit (dia- phragm, flappers gaskets, weights and hardware)		62742-00 Air chamber assembly, Pulsation dampening
	60718-00 Non-collapsible EPDM hose 2"x20'. Camlocks included		Various Wet section coatings for specific applications
	51333-10 Discharge hose, lay flat (brown) 2"x50'. Camlocks included		62301-00 SEW Movimot 24V key pad speed control
	34383-00 Stainer, sq. hole (solids) 2" FNPT		61492-00 Starter Control Panel w/ NEMA 12 protection
	61387-00 Universal sewer adapter assembly		61491-00 Transformer start/estop, w/ Nema 12 overload protection
	60536-00 Clear swing check valve 2" FPTxFPT		62974-00 3-way brass valve w/ aluminum camlocks
	60462-00 Camlock fitting 2" alum. male adapter MNPT		60506-00 The Gulper™ Suction tool No more bending